



In-flight connectivity for business aviation

Global Ku-band Advanced solution and system overview



Stay connected. Globally.

Business and life don't stop in the air. Now, neither does high-speed internet.

Viasat delivers a fast in-flight internet service for business aircraft and private jets so aircraft owners, guests, and crew can use the internet the way they want.

Ku-band Advanced provides faster speeds up to 10 Mbps in order to stay connected. No matter which service plan you choose — you'll have the speeds to do all that you want: browse the web, email, stream video and music, transfer large files and access business applications.

High-quality connectivity around the globe

Viasat in-flight internet service is available over the world's most heavily traveled routes — even over water. Our network of high-speed, cost-effective satellites delivers an excellent internet experience today and is the only path to an ultra-high capacity satellite network, ensuring business aircraft get the best service available where they fly.

Viasat services deliver predictable monthly fees, a high-speed connection, generous data allowances, and are available during all phases of flight including taxi, takeoff, and landing.

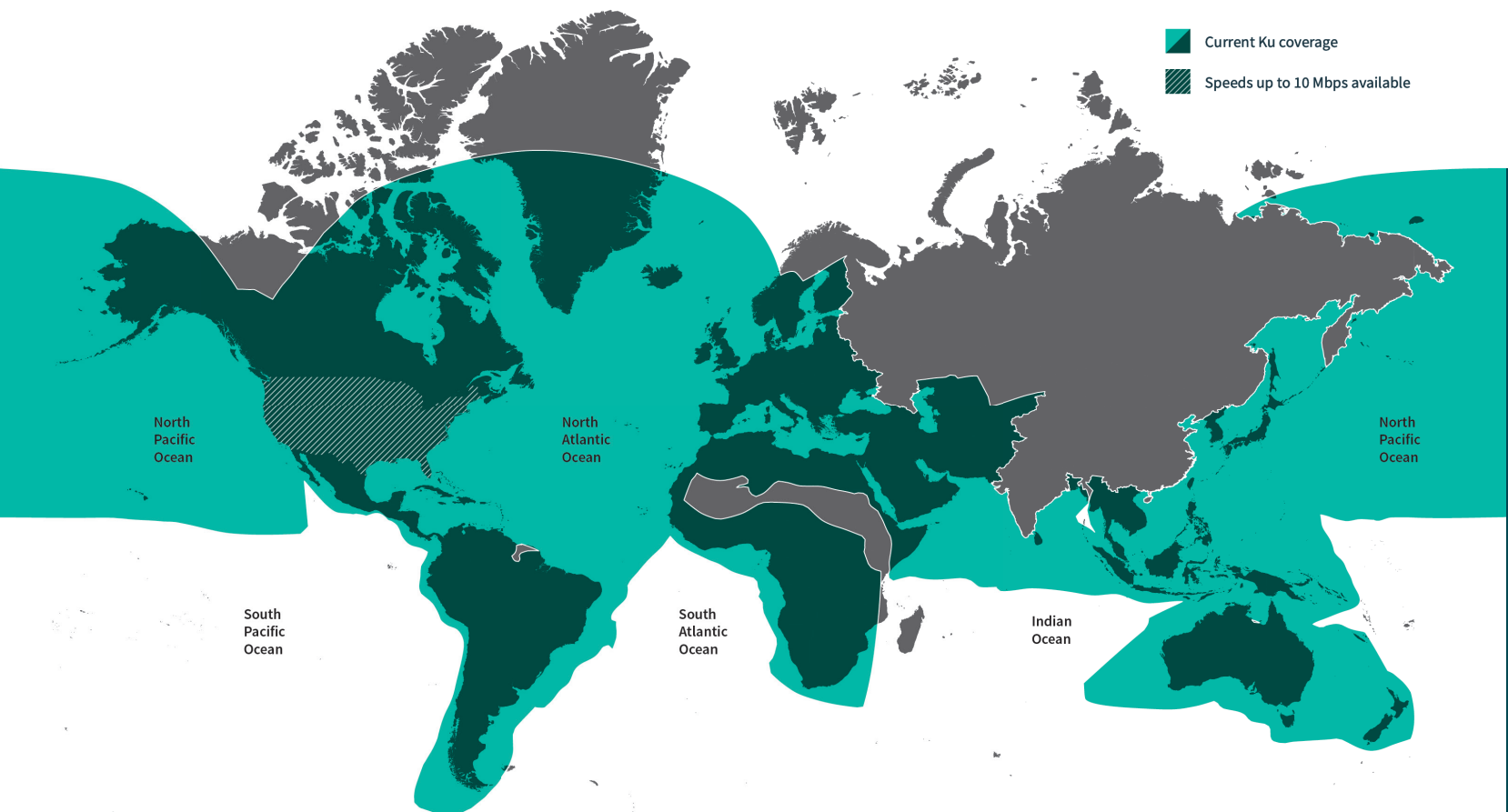

How it works

The service uses satellites to transmit data to and from the aircraft. Passengers connect their devices to the Viasat service through aircraft cabin WiFi distribution similar to how they connect to hotspots on the ground. Data is transmitted between the plane and the ground station through the satellite. As the plane moves through the air, the system automatically performs handovers between coverage areas.

VIASAT SATELLITE NETWORK

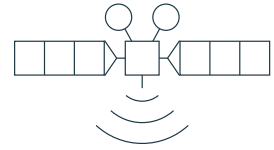

Viasat equipment and network

MODEM

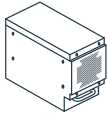

ANTENNA

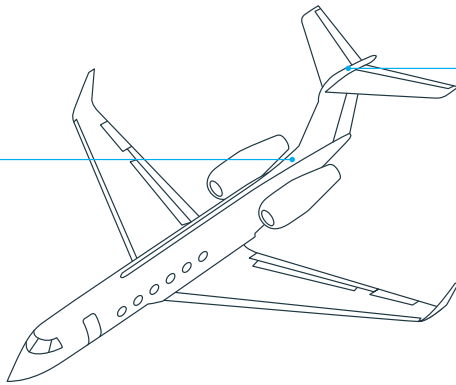
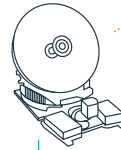

GATEWAY

CORE NODE/NOG

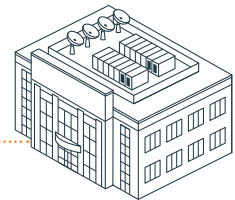

PARTNER DATA CENTER

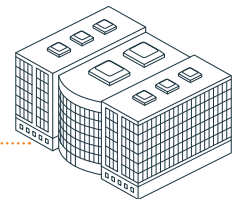

INTERNET

Equipping your aircraft

The Viasat Aero Mobile Terminal is an integral part in bringing high-speed internet service to large cabin business jets. The terminal, comprised of a small antenna, modem, and antenna control unit, integrates into the aircraft's cabin network and communicates on our network of satellites.

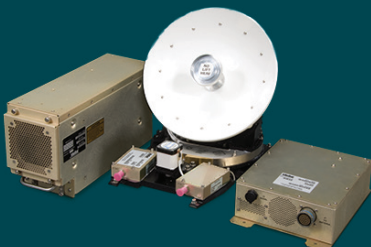

Ku-band specifications

Operating frequencies

Transmit	14.0 to 14.5 GHz
Receive	11.55 to 12.75 GHz

Baseband interfaces

Data	10/100/1000BASE-T Ethernet
Navigation required	ARINC™ 429 input

Environmental and physical characteristics

Operating temperature

› Topside equipment	-55° to +70° C
› In-aircraft equipment	-20° to +60° C

Weight, total system	32 lb; 14.5 kg
-----------------------------	----------------

Power input	28 VDC
--------------------	--------

Supported and supportable aircraft

Gulfstream	G-IV, G-V, G450, G500, G550, G600, G650/650ER
Boeing	BBJ
Cessna	Citation X
Bombardier	Challenger 600 series, Global Express, Global XRS, Global 5000–8000
Dassault	Falcon 7X, Falcon 8X

Global Ku-Advanced service plans

	Ku Advanced 30	Ku Advanced 50	Ku Advanced 70
Supported Applications	Streaming video and music, Web, VPN, email w/ attachments, VoIP and video calls (Skype, Google Hangouts)	Streaming video and music, Web, VPN, email w/ attachments, VoIP and video calls (Skype, Google Hangouts)	Streaming video and music, Web, VPN, email w/ attachments, VoIP and video calls (Skype, Google Hangouts)
To Aircraft	Up to 5 Mbps CONUS ¹ + 3 Mbps Global	Up to 7 Mbps CONUS ¹ + 4 Mbps Global	Up to 10 Mbps CONUS ¹ + 6 Mbps Global
From Aircraft	Up to 256 Kbps	Up to 512 Kbps	Up to 1 Mbps
Included data	30 GB	50 GB	70 GB
Data rollover ²	No	Yes	Yes
Coverage area	Near Global	Near Global	Near Global
Plan types	2-year, month-to-month, hourly	2-year, month-to-month, hourly	2-year, month-to-month, hourly

¹CONUS (Continental United States)

²Data rollover allows for unused data to be carried forward and used in the subsequent month. Rolled over data may only be used in the subsequent month (no month-to-month accumulation). Only available on 2-year agreement plans.

Global headquarters

6155 El Camino Real, Carlsbad, CA 92009-1699, USA

WEB viasat.com/business-aviation

TEL 888 842 7281 (US toll free)
+1 760 476 4755

EMAIL business-aviation@viasat.com

